

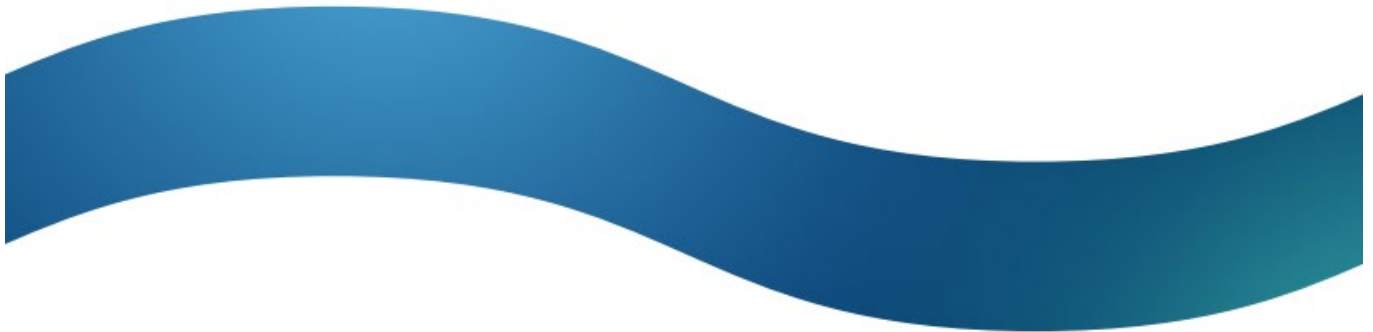

## **SHIELD MegaFi User Guide**



## Welcome

Thank you for purchasing the Nextivity SHIELD MegaFi wireless WAN router. You are on your way towards improving your cellular network coverage with the highest power modem available. In addition to the MegaFi User Guide, additional information and support for your device can be found at <https://www.nextivityinc.com>.

## Customer Responsibilities

The customer is responsible for the following:

- Providing and configuring the connected devices and configuring the MegaFi router as needed for internet and/or private wide area network access.
- Providing Internet access
  - Via the AT&T or FirstNet activated SIM on the wireless WAN connection, or
  - Via a wired ethernet connection to the WAN port
- Provide power and environmental operating conditions within the following ranges:

Parameter	Value
Temperature Range	-30°C to 65°C [-22°F to 149°F]
Relative Humidity	Up to 95%
Power	AC: 110/120 volt AC power DC: 9v to 36v DC power <b>Note:</b> MegaFi power adapters are not interchangeable with other devices. Only use the power cord supplied with your MegaFi.

- Use the local graphical user interface, Mission Control, found when connected locally to the device at <https://192.168.113.1> to accept the End User License Agreement and change the default password.
- Registering your MegaFi through the [Nextivity Cloud Portal](#) – see Section 4: 'Cloud Access via the Nextivity MegaPortal' for more information.
- Other responsibilities are specified in your End User License Agreement as well as your agreements with AT&T, FirstNet, and other providers.

## Frequently Asked Questions

**Q.** How do I determine if MegaFi will improve my cellular network connectivity?

**A.** If your enterprise or agency is located within an area in which AT&T is licensed to provide cellular service and your signal strength is two bars or less, MegaFi may be a good solution for you. MegaFi is designed to support up to 32 connected devices and is designed to provide the highest power wireless connection (WWAN) and a wired network connection (WAN) for all your edge router needs.

High-power mode will only work on Band 14. AT&T and FirstNet can help determine if your nearest tower is Band 14.

**Q.** What changes will I notice to my mobile service once I install the MegaFi?

**A.** A data session made through MegaFi will have improved signal strength, coverage, and clarity resulting in generally higher uplink speeds and lower transmit packet loss in challenging coverage areas.

Connected phones with Wi-Fi turned on will experience better calls with less drops.

**Q.** Does the MegaFi require professional installation?

**A.** Professional installation is not necessary for traditional in-office or in-home use. If installing in a vehicle or where an external antenna is needed, a professional installer is highly recommended. AT&T and FirstNet can have your device professionally installed and a quote can be obtained from AT&T, FirstNet, or your authorized seller.

**Q.** I notice I'm not getting as fast of speeds as my 5G device.

**A.** MegaFi is designed to provide consistent coverage and consistent speeds, not necessarily the fastest speeds.

**Q.** How do I log into my device for the first time?

**A.** Connect a computer (mobile phone not recommended) locally to the device with an ethernet cable or via the Wi-Fi connection:

- 1) Open your computer browser window and enter <https://192.168.113.1> and accept any browser certificate warnings to get to the local Mission Control login page.
- 2) At the Mission Control login screen, enter "**admin**" as the username and the default password, which is available from the router's label, and click **Login**.
- 3) When the End User License Agreement appears, complete the information at the bottom of the form and click **Apply**.
- 4) When directed, update your password AND press **Apply and Save**.

**Q.** How do I get support if I have more questions?

**A.** Contact the representative that sold you your MegaFi or see our website at <https://nextivityinc.com/products/shield-megafi-hpue>. You can also email support at [support@nextivityinc.com](mailto:support@nextivityinc.com).

## Safety Precautions

- When installing the equipment, all the requirements of the manufacturer and the referenced standards must be met.
- There are no user serviceable parts inside.

## Limitation of Liability

In no event shall Nextivity, nor its directors, employees, agents, suppliers or End Users, be liable under contract, tort, strict liability, negligence or any other legal or equitable theory with respect to the Products or any other subject matter of this Agreement (i) for any lost profits, cost of procurement of substitute goods or services, or special, indirect, incidental, punitive, or consequential damages of any kind whatsoever or (ii) for any direct damages in excess of (in the aggregate) the fees actually received by

Nextivity from End User with respect to the Products actually purchased and paid for.

## FCC Statement

This mobile router complies with part 15 of the FCC Rules. Operation is subject to the following two conditions: (1) This device may not cause harmful interference, and (2) this device must accept any interference received, including interference that may cause undesired operation.

This mobile router has been tested and found to comply with the limits for a Class B digital device, pursuant to Part 15 of the FCC Rules. These limits are designed to provide reasonable protection against harmful interference in a residential installation. This equipment generates, uses and can radiate radio frequency energy and, if not installed and used in accordance with the instructions, may cause harmful interference to radio communications. However, there is no guarantee that interference will not occur in a particular installation. If this equipment does cause harmful interference to radio or television reception, which can be determined by turning the equipment off and on, the user is encouraged to try to correct the interference by one or more of the following measures:

- Reorient or relocate the receiving antenna.
- Increase the separation between the equipment and receiver.
- Connect the equipment into an outlet on a circuit different from that to which the receiver is connected.
- Consult the dealer or an experienced radio/TV technician for help.

## FCC Note

**Caution:** Changes or modifications not expressly approved by the party responsible for compliance could void the user's authority to operate the equipment.

## RF Exposure Information

This device meets the government's requirements for exposure to radio waves. This device is designed and manufactured not to exceed the emission limits for exposure to radio frequency (RF) energy set by the Federal Communications Commission of the U.S. Government.

This device complies with FCC radiation exposure limits set forth for an uncontrolled environment. In order to avoid the possibility of exceeding the FCC radio frequency exposure limits, human proximity to the antenna shall not be less than 20-inches during normal operation.

## Patents

This product is covered by Nextivity, Inc., U.S. patents and patents pending. Please refer to [www.nextivityinc.com](http://www.nextivityinc.com) for details.

## Trademark

The Nextivity logo is a trademark of Nextivity, Inc.

©2023 AT&T Intellectual Property. All rights reserved. FirstNet and the FirstNet logo are registered trademarks and service marks of the First Responder Network Authority. All other marks are the property of their respective owners.

## Legal Disclaimer

For further information on terms of service and other conditions go to <http://www.nextivityinc.com/legal>.

## Contact Information

Technical Support:

**Email:** [support@nextivityinc.com](mailto:support@nextivityinc.com)

**Phone:** +1 (858) 485-9442 Option 1

Sales:

**Phone:** +1 (858) 485-9442 Option 2

## Warranty

Nextivity, Inc. provides a limited warranty for its products. For details, please refer to <https://www.nextivityinc.com/warranty>.

## Online Technical Support

For online self-help support, FAQs, documentation, and firmware downloads, go to [www.nextivityinc.com/support](http://www.nextivityinc.com/support) and select the FirstNet HPUE tab.

## User Guide Purpose

The purpose of this document is to provide the user with an introduction to the SHIELD MegaFi wireless WAN router. This guide will also provide details on installation and some interoperability scenarios.

**Note:** All images used in this document are used only for displaying examples of configurations and may not reflect the users' current device.

# Contents

1. Introduction .....	7
1.1 Description.....	7
1.2 What's Inside the Kit/Box.....	8
1.3 SHIELD MegaFi LEDs .....	9
2. Hardware Installation.....	10
2.1 Install the SIM Card (Fixed or Mobile Kits).....	10
2.2 Fixed Kit: Fixed or Office Installation .....	10
2.3 Mobile Kit: Vehicle or Mobile Installation .....	12
3. Log Into the MegaFi .....	15
3.1 Using the Mission Control Router Software.....	15
4. Cloud Access via the Nextivity MegaPortal .....	17
4.1 Create Account and Sign In .....	17
5. MegaFi Specifications .....	19
5.1 Cellular.....	19
5.2 Host Interfaces .....	19
5.3 Security .....	19
5.4 Wi-Fi.....	19
5.5 Satellite Navigation .....	20
5.6 Environmental.....	20
5.7 Power (Fixed and Mobile).....	20
5.8 Network and Routing.....	21
5.9 Reliability .....	21
5.10 Supported Warranty.....	21
5.11 Mechanical and Packaging .....	21
5.12 Antennas.....	21
5.13 Dimensions.....	22

# 1. Introduction

The SHIELD MegaFi High Power User Equipment (HPUE) mobile router for critical communications is the highest-power modem available.

It can boost cellular transmission strength by up to 6x, so users can maintain critical connectivity throughout more of their areas of operation than ever before.

**Features and benefits include:**

- FirstNet Trusted™ device (go to <https://www.firstnet.com> for more information)
- Significantly increase coverage in rural and dense urban areas
- Five-port Ethernet router
- GPS and location base services
- Wi-Fi hotspot
- Intuitive graphical user interface for easy configuration
- Internet routing capability

MegaFi is an all in one, cloud-supported, and SD-WAN capable mobile, Wi-Fi router. This certified FirstNet Trusted™ device works on AT&T and FirstNet high power mode Band 14, as well as additional bands in regular power mode and is available in both a Fixed and Mobile configuration. The box includes the antennas and power adapter, or cables based on your configuration, and the MegaFi router has an integrated, ruggedized mount for easy installation.

Currently, the SHIELD MegaFi mobile router device can be found in two (2) different kits:

- **SHIELD MegaFi Mobile** (SKU # M23-UC-V01)
- **SHIELD MegaFi Fixed** (SKU # M23-UC-F01)

Learn more about SHIELD MegaFi: [www.nextivityinc.com/products/shield-megafi-hpue/](http://www.nextivityinc.com/products/shield-megafi-hpue/)

## 1.1 Description

The MegaFi router has six (6) subminiature version A (SMA) connectors that are labeled: Wi-Fi 1, GPS, PRI, B14, DIV, and Wi-Fi 2.

**Note:** Wi-Fi 1 and 2 are both reverse SMA connectors.

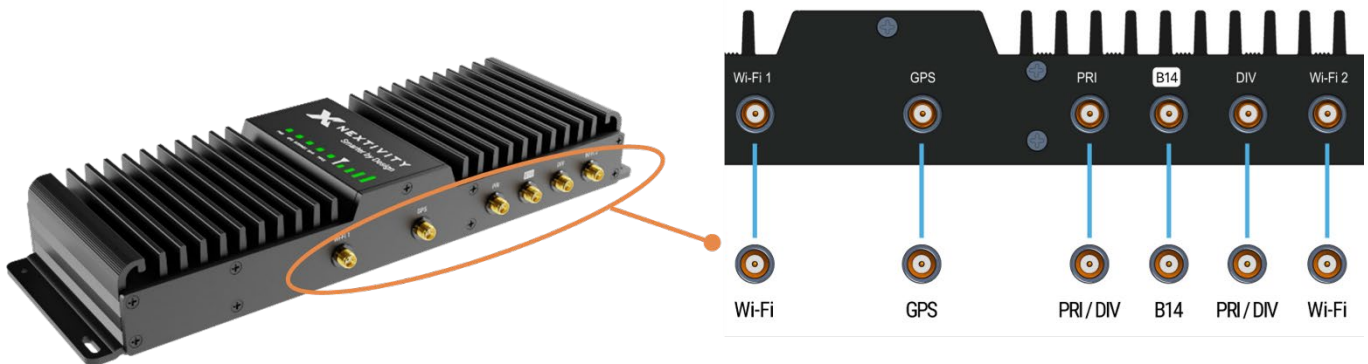

On the other side of the device, there are:

- Four (4) local-area network (LAN) ports
- One (1) wide-area network (WAN) port
- SIM Slot
- USB Connector
- Reset Button
- Power Port



On the top of the device, there is an LED section that has lights for:

- PWR
- GPS, Internet
- Wi-Fi
- High Power User Equipment (HPUE)
- Signal Strength Bars



Underneath the device, you will find a label that shows the following information:

- Model
- IMEI
- Serial Number
- MAC address
- Default IP address
- User: admin (default) and unique password
- SSID and password (default values)
- QR code
- \*An example of the label and QR code can be found in section 5.13: Dimensions

## 1.2 What's Inside the Kit/Box

The SHIELD MegaFi comes in two (2) different kits. The different kits with their respective list of parts are listed below.

### SHIELD MegaFi Fixed Kit:

- High Power MegaFi Router
- AC power adapter
- SIM Ejector Tool (not pictured)
- Ethernet cable
- Paddle antennas – 2x PRI/DIV (black), 2x Wi-Fi (gray), 1x B14 (white)
- GPS antenna
- Quick Start Guide for quick router configuration and connection (not pictured)





**SHIELD MegaFi Mobile Kit:**

- High Power MegaFi Router
- Locking DC power cable
- SIM Ejector Tool (not pictured)
- Roof mount 6-in-1 antenna includes 3x cellular, 2x Wi-Fi and 1x GPS connections
- Ethernet cable
- Quick Start Guide for quick router configuration and connection (not pictured)



**1.3 SHIELD MegaFi LEDs**

The SHIELD MegaFi device will take about three to five minutes to boot up and the local management interface, Mission Control, MegaFi’s Graphical User Interface (GUI), and an Internet connection will not be available during boot up. More information about Mission Control will be discussed in a later section.

After the boot up process, the LEDs will turn ON and have the following indications:

LED	Color/Pattern	Description
<b>PWR</b>	<b>Off</b>	No power or input voltage
	<b>Solid Green</b>	Power is present - On
<b>GPS</b>	<b>Off</b>	No GPS resolution is possible
	<b>Blinking Green</b>	Searching for GPS
	<b>Solid Green</b>	GPS location is available
<b>INTERNET</b>	<b>Solid Red</b>	No WAN or WWAN connection available
	<b>Blinking Red</b>	No SIM card is detected
	<b>Solid Blue</b>	Connected to WAN only, and no WWAN connection is available
	<b>Blinking Green</b>	Attempting to connect to network
	<b>Solid Green</b>	Connected to WWAN or both a WWAN and WAN connection
<b>Wi-Fi</b>	<b>Off</b>	Wi-Fi disabled
	<b>Solid Green</b>	Wi-Fi enabled and On
<b>HPUE</b>	<b>Solid Green</b>	In regular power mode
	<b>Solid Blue</b>	In high power mode
<b>Signal Bars</b>	<b>Off</b>	No signal strength available from the network
	<b>Green</b>	Number of bars lit based on signal strength available from the network
<b>LAN/WAN Port LEDs</b>	<b>Top Left</b>	Off if no device connected. Solid Amber if connection detected and blinking Amber if sending or receiving traffic.
	<b>Top Right</b>	Solid Green means port is enabled

## 2. Hardware Installation

Depending on the kit, 'Fixed' versus 'Mobile', refer to the appropriate section and steps below for installation details.

### 2.1 Install the SIM Card (Fixed or Mobile Kits)

**Note:** If the SIM card has been pre-installed, skip this part.

- 1) Remove the SIM card cover by pressing a thumbnail or flathead screwdriver in the gap between the metal and plastic located on the left side of the unit as shown. You should now see the edge of the silver SIM tray.

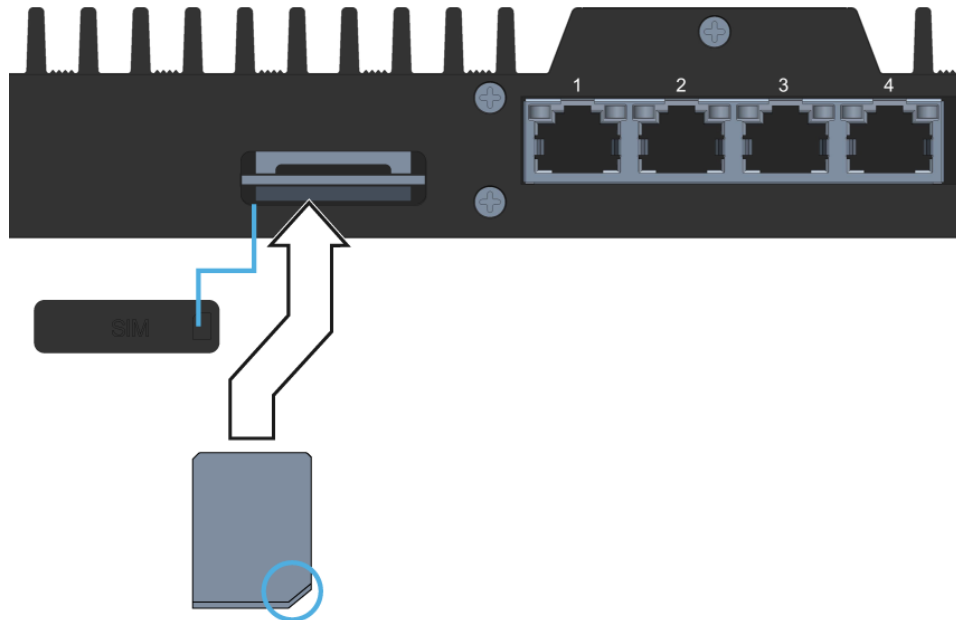

- 2) Remove the SIM tray with the included SIM Ejector Tool by inserting the tool into the hole on the SIM tray; the tray should pop partway out. Remove the SIM tray completely.
- 3) Insert your activated SIM into the tray, insert the tray into the slot, and press the cover back into place.

**Note:** The SIM tray is notched so align the card in the tray accordingly.

### 2.2 Fixed Kit: Fixed or Office Installation

There is an installation video located at <https://go.nextivityinc.com/megafi-fixed-installation-guide> that may assist in providing an overview of the steps to a successful vehicle installation.

Below are detailed steps for installing the Fixed MegaFi kit.

**Note:** Only use the power cord supplied with your MegaFi.

## Attach the Antennas:

- 1) The antennas are labeled and will be screwed onto the port as noted in the Quick Start Guide included in the box.
- 2) Take care when attaching the antennas as connecting the antenna incorrectly may damage the antenna or the MegaFi. Finger-tight should be sufficient.

**Note:** SMA connectors have a maximum torque of 3-5 inch lbs. Over-torquing may damage the connectors and void warranty.

- 3) For best performance it is highly recommended to locate the MegaFi near a southern facing window for best GPS coverage and the unit needs to be installed more than 20" away from any users as per the FCC rules for the MegaFi.

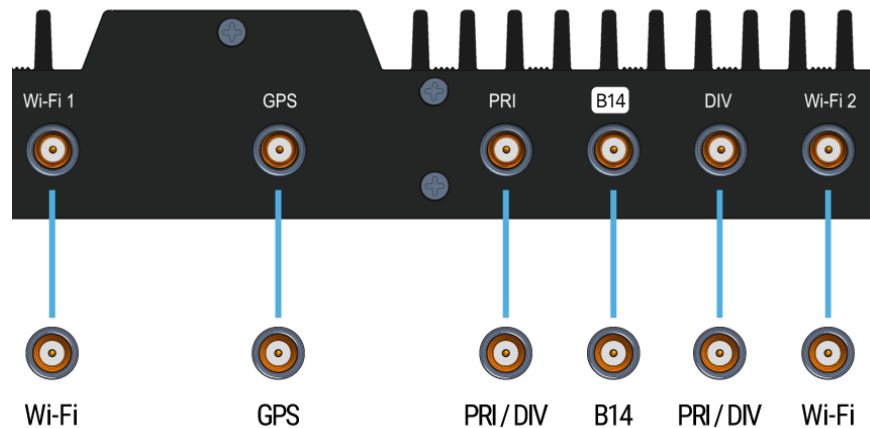

## Connect Power:

Attach the included AC power adapter to the MegaFi and plug into a standard outlet.

**Note:** Use only the AC adapter supplied with your MegaFi, as other adapters may not have enough current to properly power the MegaFi.

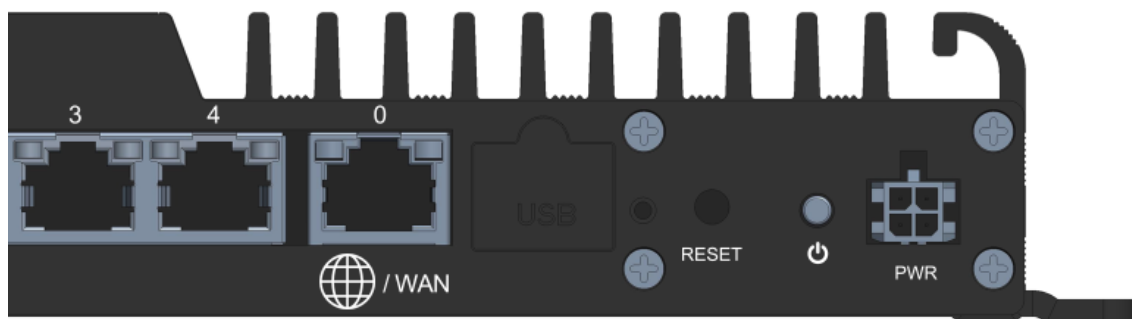

## Boot Up:

Once the power is connected, the LEDs will flash. The system may take a few minutes to boot up. During that time the PWR LED should remain lit. When the unit is successfully connected, the "INTERNET" LED will show a solid green light.

Refer to Section 1.3 'SHIELD MegaFi LEDs' for further information.



## 2.3 Mobile Kit: Vehicle or Mobile Installation

**Note:** Installing and activating a SHIELD MegaFi router in your vehicle is straightforward for those familiar with installing other after-market antenna-connected systems. If you are planning a self-installation and are not a professional, it is recommended that you seek guidance from someone with hands-on experience with similar products. For help locating an expert installer, contact Nextivity support at [support@nextivityinc.com](mailto:support@nextivityinc.com).

There is an installation video located at <https://go.nextivityinc.com/megafi-mobile-installation-guide> that may assist in providing an overview of the steps to a successful vehicle installation.

Below are detailed steps for the Mobile MegaFi kit.

### Required Hardware and Tools:

**Note:** Nextivity does not provide screws or other hardware that may be needed to secure the MegaFi and related components as installation varies widely depending on how and where in the vehicle the system is installed.

- 1) Screwdriver or other hand/power tools as needed
- 2) Hardware for installation

**Note:** Before you start drilling holes or permanently attaching the MegFi to the vehicle, make sure the cables from the antenna will reach from the mounting point of the antenna to the location of the installed MegaFi, leaving enough cable length for stress relief before connecting to the SMA connectors. See more information below in the section 'Connect Antenna Cables to MegaFi'.

### Mount the Antenna on the Roof:

- 1) Select a location for the antenna. For best performance it is highly recommended to locate the antenna:
  - A. At least 30" from all other antennas
  - B. Within 15' of where you will mount the MegaFi unit, so the connection cables can reach the MegaFi unit in the vehicle
  - C. At least 12" from the edge of the roof
  - D. 20" or more from vehicle occupants per FCC rules for use of the MegaFi
- 2) Mount the antenna per the antenna manufacture

**Note:** You can find the Parsec Australian Shepherd antenna information at [www.parsec-t.com/product/australian-shepherd-hpue-optimized/](http://www.parsec-t.com/product/australian-shepherd-hpue-optimized/). Pay close attention to the antenna labeling, they may be different.

### To Mount the Antenna:

**Note:** You can find installation instructions for the Parsec Australian Shepard antenna at [www.parsec-t.com/wp-content/uploads/2022/11/Australian-Shepherd-HPUE-Optimized-Installation-Instructions.pdf](http://www.parsec-t.com/wp-content/uploads/2022/11/Australian-Shepherd-HPUE-Optimized-Installation-Instructions.pdf).

- A. Drill a hole in the roof or other suitable flat, horizontal to the earth surface, of the vehicle.
- B. Gently place the antenna on the roof and feed the cables through the hole. To fully seat the antenna on the roof, peel the backing to expose the adhesive and press the antenna firmly into place.

### Install the SHIELD MegaFi Unit Inside the Vehicle:

- 1) Place the unit on a suitable flat surface within the vehicle leaving clearance for cable and power connections. The location should be dry and as far away from openings as is reasonable and be within easy reach of the antenna cables.

**Note:** Leave at least a 2-inch space (air gap) open above the MegaFi to ensure proper cooling, and never place any other devices directly on the MegaFi.

- 2) Secure the unit with four screws appropriate for the material the MegaFi is being mounted on.

### Connect Antenna Cables to MegaFi:

- 1) Each antenna cable is appropriately labeled. Connect each cable to its designated connector on the MegaFi device.

**Note:** SMA connectors have a maximum torque of 3-5 inch lbs. Over-torquing may damage the connectors and void warranty.

**Note:** It is highly recommended to apply stress relief to the end of the cables right before connecting to the MegaFi. Typically, this is done by making a loop of the cables and then attaching them to the designated SMA connectors of the device as shown below.



### Connect the Power:

#### Wiring Diagram – Example Installation

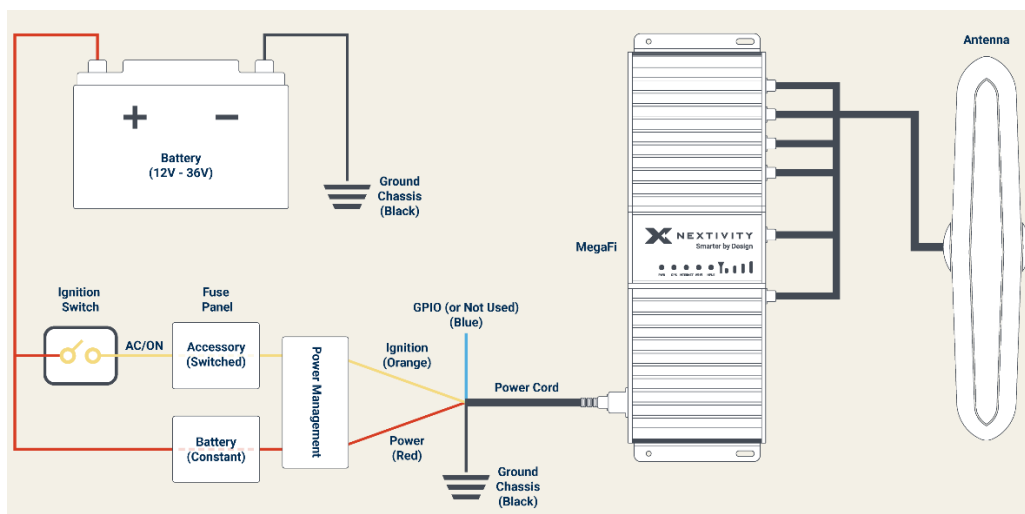

- 1) Connect the DC power cable to the port labeled PWR on the side of the device.
- 2) Connect the DC power cable to your DC power source.

**Note:** Red = + Positive; Black = - Negative; Orange = Ignition Sense; Blue = GPIO or Sleep Sense (not used in all applications)

3) Connect each wire to the corresponding location on the Power Management block in the vehicle.

### Boot Up:

Once the antennas and power are connected, start or power on the vehicle. The LEDs will flash. The system may take a few minutes to boot up. During that time the PWR LED should remain lit. When the unit is successfully connected, the "INTERNET" LED will show a solid green light.

## 3. Log Into the MegaFi

Mission Control is the built-in web interface that provides information about the SHIELD MegaFi router and allows the user to configure settings to their preferences.

This chapter describes how to log in to Mission Control.

### 3.1 Using the Mission Control Router Software

1) Connect an Ethernet cable between your computer and any LAN port (1-4) on the MegaFi.

2) Open a web browser to the following default LAN IP address: <https://192.168.113.1>

**Note:** Chrome seems to be the best browser to use for accessing the MegaFi via Mission Control.

3) The first time you try to connect to MegaFi, a couple of connection warnings will display as shown below. Accept the first connection warning by clicking on 'Advanced'.

**Note:** These connection warnings are typical of web browsers looking after the user when attempting to log on to specific devices or websites. Since we are aware of what we are connecting to, we proceed as instructed. After logging off from MegaFi for some time, the user will encounter these warnings again when attempting to reconnect. When this happens, proceed as instructed.

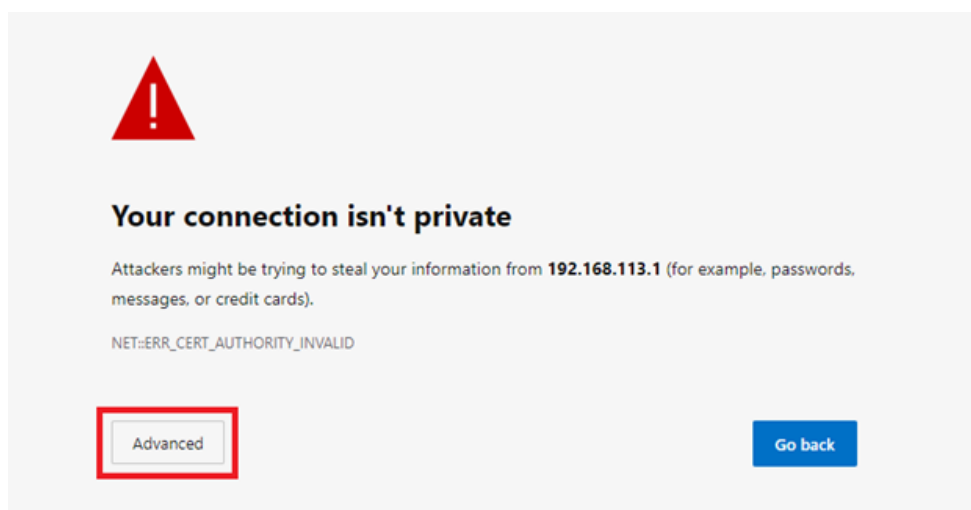

4) Click on 'Continue to 192.168.113.1 (unsafe)' link to proceed.

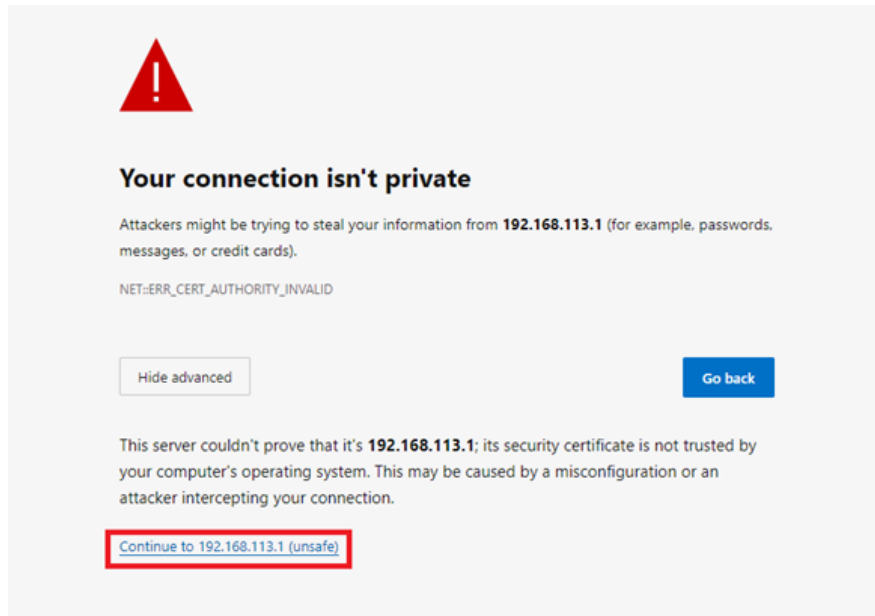

- 5) The MegaFi's Mission Control GUI login page will now be displayed.
- A. Enter the default password as found on the bottom label of the MegaFi.
- Note:** username always defaults to 'admin'.
- B. Click 'Login' to proceed.

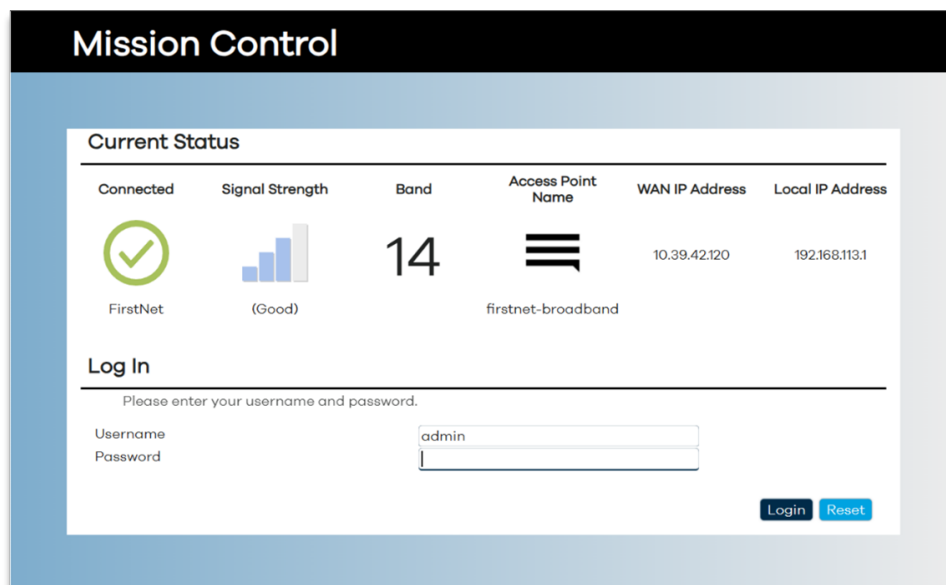



- 6) When logging in for the first time, the EULA (End User License Agreement) will be displayed.
  - A. Fill out the requested information and click '**Accept**' to continue.

**End User Licence Agreement**

Nextivity Inc. ("Nextivity")  
End User License Agreement ("EULA")  
Version Date: July 25, 2023

BY ACCEPTING THIS EULA, EITHER BY INDICATING YOUR ACCEPTANCE, BY EXECUTING A QUOTE OR ORDERING EQUIPMENT OR SERVICES DIRECTLY WITH US OR THROUGH AN APPROVED NEXTIVITY DISTRIBUTOR OR RESELLER (HOWEVER TITLED, REFERRED TO HEREIN AS AN "ORDER"), OR BY DOWNLOADING, INSTALLING AND/OR UTILIZING ANY OF THE SERVICES (DEFINED BELOW), YOU AGREE TO THE TERMS AND CONDITIONS OF THIS EULA. THIS EULA IS A LEGALLY BINDING CONTRACT BETWEEN YOU AND NEXTIVITY AND SETS FORTH THE TERMS THAT GOVERN THE LICENSES PROVIDED TO YOU HEREUNDER. IF YOU ARE ENTERING INTO THIS EULA ON BEHALF OF A COMPANY OR OTHER LEGAL ENTITY, YOU REPRESENT THAT YOU HAVE THE AUTHORITY TO BIND SUCH ENTITY TO THIS EULA. ANY CHANGES, ADDITIONS OR DELETIONS BY YOU TO THIS EULA WILL NOT BE ACCEPTED AND WILL NOT BE A PART OF THIS EULA. IF YOU DO NOT AGREE TO THIS EULA, YOU MUST NOT DOWNLOAD, INSTALL, OR USE THE SERVICES.

This Nextivity End User License Agreement ("EULA") is between Nextivity (or "we" or "us") and the user ("User" or "You" or "Your") of the Services, as defined below. This EULA applies to Your use of:

- (1) the Nextivity equipment ("Equipment");
- (2) the Nextivity on-premises, installed software that initialize and enables the Equipment ("Installed Software");
- (3) the Nextivity cloud-based software that allows You to manage and configure Your Equipment ("Cloud Software");
- (4) the written and visual materials Nextivity may provide to aid You in Your use of the Equipment, Installed Software and Cloud Software ("Documentation"); and
- (5) any training or support services performed, either remotely or in person, by Nextivity ("Support"). The Installed Software and Cloud Software may be referred to together as the "Software." The Software, Equipment, Documentation and Support may be referred to collectively as the "Services." This EULA also incorporates any Equipment-specific terms that may apply to the Equipment You acquire ("Supplemental Terms").

**Section 1. Using the Services**

**1.1 License and Right to Use.** Nextivity grants You a non-exclusive, non-transferable, non-sublicensable, revocable (a) license to use the installed Software; (b) right to use the Cloud Software; and (c) right to use the Documentation solely in connection with Your use of the Software and Equipment, each as acquired from Nextivity or an approved reseller or distributor of Nextivity ("Approved Provider"), solely for Your internal business purposes during the Usage Term (as defined in Section 1.6 below), subject to the terms of this EULA and the applicable Order (collectively, the "Usage Rights"). Nextivity reserves all rights, title, and interest in and to the Services, including all related intellectual property rights, subject to the limited rights expressly granted hereunder.

First Name

Last Name

Company (optional)

Phone (optional)

E-Mail

- 7) You will then be directed to update your password. Please update the password and click **Apply and Save**.

**Note:** A factory reset restores the original default password. The password is only available from the printed label and label QR code.

**Note:** For further information regarding monitoring and configuration settings in Mission Control for MegaFi, please refer to the MegaFi Software Guide.

## 4. Cloud Access via the Nextivity MegaPortal

Once the MegaFi has been setup, installed, and pre-configured to minimum requirements, it is time to register and connect the device to the Nextivity Cloud Portal also known as MegaPortal.

### 4.1 Create Account and Sign In

- 1) To enable cloud management, open your computer browser window and enter <https://mega.nextivityinc.com>.
- 2) The MegaPortal sign-in dialog box will appear after bypassing the warning messages.



- A. If your organization already has an account, contact your organization's administrator to create a user account.
- B. If your organization does not yet have an account, contact [support@nextivityinc.com](mailto:support@nextivityinc.com) to create an administrative account for your organization.
- C. To create the first administrative account for your organization, you'll need to provide the following information:
  - Organization Name
  - Your Name
  - Phone Number
  - Email
- D. If you already have an account, enter the email and the password for your account and click **Sign In**. If MFA has been enabled on your account, enter the MFA code sent to you to complete the log in process.

**Note:** For further information regarding MegaPortal for MegaFi, please refer to the MegaPortal Guide.

## 5. MegaFi Specifications

### 5.1 Cellular

LTE Category	Cat 12 modem
Peak D/L	Up to 600 Mbps
Peak U/L	Up to 150 Mbps
4G LTE	1900 (B2), AWS (B4), 850 (B5), 700 (B12), 700 (B14), 700 (B17), 700 (B29), 2300 (B30), 1700 (B66)
Approvals	FCC, PTCRB, Wi-Fi Alliance
Carrier	AT&T / FirstNet
Compliance	RoHS

### 5.2 Host Interfaces

5 Gigabit RJ-45 Ethernet ports	1 WAN and 4 LAN
1 SIM Slot	3FF MicroSIM
4 SMA antenna connectors	1 Band 14, 1 primary cellular, 1 diversity cellular, 1 GPS
2 RP-SMA antenna connectors	Dual band Wi-Fi (2.4 and 5 GHz)

### 5.3 Security

AAA	802.1x/Radius authentication with Wi-Fi and Ethernet
Firewall	Port forwarding and filtering
WLAN Encryption	WPA2-PSK, WPA2-PSK/WPA3-SAE, WPA3-SAE
WLAN MAC	Address filtering

### 5.4 Wi-Fi

Band Support	Dual Band 2.4/5 GHz 2x2 MIMO 802.11 a/b/g/n/ac
Recommended Maximum Users	32 clients

## 5.5 Satellite Navigation

Dedicated multi-band and multi-channel GNSS Receiver supporting	GPS, Galileo (L1, L5)
Sensitivity	-162 dBm
Reports (Update Rate 1Hz)	NMEA, TAIP (PPS)
Reliable Store and Forward via serial	UDP

## 5.6 Environmental

Operating Temperature (°F (°C))	-30 to +65 (-22 to +149)
Storage Temperature (°F (°C))	-40 to +90 (-40 to +194)
Operating humidity	(non-condensing) 0 to 95%
Shock, vibration	MIL-STD-810G
Road vehicles - electrical test	ISO-7637-2
Ingress Protection	IP-54
Material flammability	UL94

## 5.7 Power (Fixed and Mobile)

Input/Operating Voltage	9 to 36 VDC
Power modes	ON 18W Typical (1.5A @12V); Standby 120mW (10mA@12V)
Built-in protection against voltage transients including VDC engine cranking	
Ignition Sense with time delay shutdown	

## 5.8 Network and Routing

Custom APN	Static IP(s) provided by AT&T/FirstNet
Network Address Translation (NAT)	
LAN Segmentation	
WAN/LAN Connection Policy Management	
QoS	Application/ Traffic Priority Queuing
WAN Monitors	Connection Failure Recovery
Configurable MTU size	Adjust for FirstNet WWAN and VPN specific requirements
Multiple LAN Support	
Customize transmission buffer size	
Static Routing	
WAN Ethernet	

## 5.9 Reliability

MTBF	>10 years
------	-----------

## 5.10 Supported Warranty

2-year standard warranty; Optional warranty up to 5 years. Includes unrestricted device software upgrades	For more information contact support@nextivityinc.com
---	---

## 5.11 Mechanical and Packaging

Weight	1lb 14 oz
--------	-----------

## 5.12 Antennas

Fixed	Paddle antennas – 2x PRI/DIV (black), 2x Wi-Fi (gray), 1x B14 (white)
Mobile	Vehicle mount antenna in box includes 6-in-1 antenna including Cell-1 B14, Cell-2, Wi-Fi1, Wi-Fi2, and 1 GPS.

## 5.13 Dimensions

